

Reading Test

65 MINUTES, 52 QUESTIONS

Turn to Section 1 of your answer sheet to answer the questions in this section.

DIRECTIONS

Each passage or pair of passages below is followed by a number of questions. After reading each passage or pair, choose the best answer to each question based on what is stated or implied in the passage or passages and in any accompanying graphics (such as a table or graph).

Questions 1-10 are based on the following passage.

This passage is from Susan Vreeland, *Clara and Mr. Tiffany*. ©2011 by Susan Vreeland. The narrator is meeting with her former employer, Louis Comfort Tiffany, an artist whose company later became famous for designing stained glass lampshades.

“I’ve come to inquire if you have work for me. That is, if my performance pleased you before.” A deliberate prompt. I didn’t want to be hired because of my need or his kindness. I
Line wanted my talent to be the reason he wanted me back.

5 “Indeed” was all he offered.

What now to fill the suspended moment? His new projects. I asked. His eyebrows leapt up in symmetrical curves.

“A Byzantine chapel for the World’s Columbian
10 Exposition in Chicago next year. Four times bigger than the Paris Exposition Universelle. It will be the greatest assembly of artists since the fifteenth century.” He counted on his fingers and then drummed them on the desk. “Only fifteen months away. In 1893 the name of Louis Comfort Tiffany
15 will be on the lips of millions!” He stood up and swung open his arms wide enough to embrace the whole world.

I sensed his open palm somewhere in the air behind the small of my back, ushering me to his massive, carved mahogany exhibit table to see his sketches and watercolors.
20 “Two round windows, The Infancy of Christ and Botticelli’s Madonna and Child, will be set off by a dozen scenic side windows.”

A huge undertaking. How richly fortunate. Surely there would be opportunity for me to shine.

25 Practically hopping from side to side, he made a show of slinging down one large watercolor after another onto the Persian carpet, each one a precise, fine-edged rendering of what he wanted the window to be.

“Gracious! You’ve been on fire. Go slower! Give me a
30 chance to admire each one.”

He unrolled the largest watercolor. “An eight-foot mosaic behind the altar depicting a pair of peacocks surrounded by grapevines.”

My breath whistled between my open lips. Above the
35 peacocks facing each other, he had transformed the standard Christian icon of a crown of thorns into a shimmering regal headdress for God the King, the thorns replaced by large glass jewels in true Tiffany style.

Astonishing how he could get mere watercolors so deep
40 and saturated, so like lacquer that they vibrated together as surely as chords of a great church pipe organ. Even the names of the hues bore an exotic richness. The peacocks’ necks in emerald green and sapphire blue. The tail feathers in vermilion, Spanish ocher, Florida gold. The jewels in the
45 crown mandarin yellow and peridot. The background in turquoise and cobalt. Oh, to get my hands on those gorgeous hues. To feel the coolness of the blue glass, like solid pieces of the sea. To chip the gigantic jewels for the crown so they would sparkle and send out shafts of light.
50 To forget everything but the glass before me and make of it something resplendent.

When I could trust my voice not to show too much eagerness, I said, “I see your originality is in good health. Only you would put peacocks in a chapel.”

55 “Don’t you know?” he said in a spoof of incredulity. “They symbolized eternal life in Byzantine art. Their flesh was thought to be incorruptible.”

“What a lucky find for you, that convenient tidbit of information.”

60 He chuckled, so I was on safe ground.

He tossed down more drawings. “A marble-and-mosaic altar surrounded by mosaic columns, and a baptismal font of opaque leaded glass and mosaic.”

“This dome is the lid of the basin? In opaque leaded
65 glass?”

He looked at it with nothing short of love, and showed me its size with outstretched arms as though he were hugging the thing.

I was struck by a tantalizing idea. “Imagine it reduced in
70 size and made of translucent glass instead. Once you figure how to secure the pieces in a dome, that could be the method and the shape of a lampshade. A wraparound window of, say”—I looked around the room—“peacock feathers.”

75 He jerked his head up with a startled expression, the idea dawning on him as if it were his own.

“Lampshades in leaded glass,” he said in wonder, his blue eyes sparking.

“Just think where that could go,” I whispered.

1

Which choice best describes what happens in the passage?

- A) The narrator reflects on how the behavior of another character has changed.
- B) The narrator struggles to understand the motivations of another character.
- C) The narrator discusses shared professional interests with another character.
- D) The narrator recounts the events that led another character to support her project.

2

According to the passage, Tiffany looks forward to the upcoming World’s Columbian Exposition in Chicago as an opportunity to

- A) gain greater popular recognition.
- B) sell many decorative objects.
- C) collaborate with other famous artists.
- D) showcase pieces that have earned critical acclaim.

3

The narrator indicates that Tiffany informs her of his new projects by

- A) showing a series of plans for stained glass windows he intends to construct.
- B) presenting several finished stained glass windows and describing them in detail.
- C) asking her opinion of the watercolor paintings he plans to exhibit in Chicago.
- D) displaying a chart that shows the placement of the artworks he plans to exhibit in Chicago.

4

Which choice best supports the idea that the narrator recognizes the potential importance of her contribution to Tiffany’s business?

- A) line 34 (“My breath . . . lips”)
- B) lines 46-47 (“Oh, to . . . hues”)
- C) line 69 (“I was . . . idea”)
- D) line 79 (“Just . . . whispered”)

5

As used in line 38, “true” most nearly means

- A) honest.
- B) characteristic.
- C) loyal.
- D) factual.

6

In context, the narrator’s reference to a “pipe organ” (line 41) mainly serves to

- A) suggest that Tiffany draws inspiration for his artworks from music.
- B) reveal her surprise at Tiffany’s decision to create watercolor paintings.
- C) illustrate her perception of the vividness of the colors used by Tiffany.
- D) provide an example of an image Tiffany depicts in one of his watercolors.

7

The narrator’s remarks in lines 53-54 (“I see . . . chapel”) and lines 58-59 (“What . . . information”) are best described as expressing the narrator’s

- A) envious resentment of Tiffany’s talents as an artist.
- B) good-natured amusement at Tiffany’s creative tendencies.
- C) long-standing puzzlement at Tiffany’s unconventional choices.
- D) open admiration of Tiffany’s unique vision.

8

In context, the description in lines 66-68 (“He looked . . . thing”) contributes to the passage’s overall characterization of Tiffany mainly by

- A) suggesting his tendency to exaggerate his own importance.
- B) conveying his preference for creating large-scale artworks.
- C) demonstrating the personal warmth he expresses toward others.
- D) emphasizing the intensity of his excitement about his work.

9

It can most reasonably be inferred from the passage that the narrator’s talents include an ability to

- A) devise imaginative names for the colors of the glass she works with.
- B) enhance an existing idea by improvising technical innovations for artworks.
- C) provide authoritative critiques of classical artworks.
- D) create detailed sketches on which larger artworks are based.

10

Which choice provides the best evidence for the answer to the previous question?

- A) lines 34-38 (“Above . . . style”)
- B) lines 42-44 (“The peacocks’ . . . gold”)
- C) lines 61-63 (“He tossed . . . mosaic”)
- D) lines 69-72 (“Imagine . . . lampshade”)

Questions 11-20 are based on the following passage and supplementary material.

This passage is adapted from Richard Florida, "Bigger Isn't Necessarily Better When It Comes to City Size." ©2017 by The Atlantic Monthly Group.

A pair of recent studies suggests that although industrialized nations may have benefitted from larger cities, the same is not true for the rapidly urbanizing areas of the developing world. In these parts of the globe, there really might be such a thing as too much urbanization, too quickly.

The studies, by Susanne A. Frick and Andrés Rodríguez-Pose of the London School of Economics, take a close look at the actual connection between city size and nationwide economic performance. Their initial study, from last year, examines the relationship between economic development, as measured by GDP per capita, and average metropolitan-area size in 114 countries across the world between 1960 and 2010. To ensure robustness, it controls for variables including national population size, physical land area, education levels, economic openness, and other factors.

The size of cities or metro areas across the world has exploded over the past half-century, with cities in the developing world growing much faster and much larger than those in more developed nations. Between 1960 and 2010, the median city in high-income countries grew modestly from 500,000 to 650,000 people; but the median city in the developing world nearly quadrupled, expanding from 220,000 to 845,000 people. In 1960, 12 of the top 20 countries with the largest average city size were high-income countries; by 2010, 14 of the top 20 were in the developing world.

Urbanization has historically been thought of as a necessary feature of economic development and growth, but this study finds the connection is not so simple. While advanced nations benefit from having larger cities, developing nations do not. Advanced nations experience a 0.7 percent increase in economic growth for every additional 100,000 in average population among its large cities over a five-year period. But for developing nations, the addition of 100,000 people in large cities is associated with a 2.3 percent decrease in economic growth over a five-year period.

In their latest study, the researchers found that developing nations tend to get a bigger bang for their buck from smaller and medium-size cities. These countries see the most economic benefit from having a larger proportion of their urban population living in cities of 500,000 people or less. Bigger cities tend to have a more positive economic impact in larger countries. Having a metro with more than 10 million inhabitants produces a nationwide economic benefit only if the total urban population is 28.5 million

or more, according to the study. This makes sense: Bigger, more developed countries are more likely to play host to knowledge-based industries that require urban agglomeration economies.

There are several reasons why megacities¹ often fail to spur significant growth in the rapidly urbanizing world. For one, the lion's share of places that are urbanizing most rapidly today are in the poorest and least-developed parts of the world, whereas the places that urbanized a century or so ago were in the richest and most developed. This history has created a false expectation that urbanization is always associated with prosperity.

Additionally, globalization has severed the historical connection between cities, local agriculture, and local industry that powered the more balanced urban economic development of the past. In today's globally interconnected economy, the raw materials that flowed from the surrounding countryside to the city can all be inexpensively imported from other parts of the world. The result is that the connection between large cities and growth has now become much more tenuous, producing a troubling new pattern of "urbanization without growth."

Median of City Population Size in High-Income and Developing Countries from 1960 to 2010

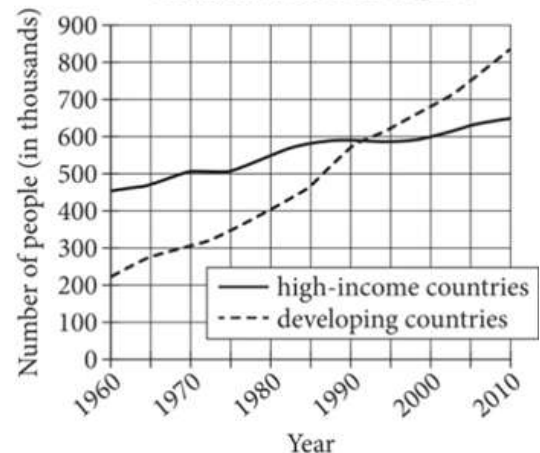

Adapted from Susanne A. Frick and Andrés Rodríguez-Pose, "Average City Size and Economic Growth." ©2016 by Susanne A. Frick and Andrés Rodríguez-Pose.

The researchers used multiple variables to calculate a weighted average city size for each country studied and reported the median of those averages.

¹ Typically defined as cities with populations of over ten million people

11

The main purpose of the passage is to

- A) describe the causes and consequences of a phenomenon.
- B) propose a new solution to an ongoing problem.
- C) question whether recent research has practical applications.
- D) critique the methodology used to arrive at new findings.

12

Which choice best supports the idea that a country's unique circumstances are likely to distort comparisons between its economic growth and urban population size and those of other countries?

- A) lines 1-4 ("A pair . . . world")
- B) lines 14-16 ("To ensure . . . factors")
- C) lines 32-35 ("Advanced . . . period")
- D) lines 44-45 ("Bigger . . . countries")

13

Based on the passage, which choice best describes the relationship between Frick and Rodríguez-Pose's first and second studies?

- A) The second study corrects a minor error in the research of the first study.
- B) The second study confirms a hypothesis that they were unable to confirm in the first study.
- C) The second study builds on the first study's findings.
- D) The second study offers a more negative interpretation of a recent event than the first study does.

14

As used in line 29, "feature" most nearly means

- A) specialty.
- B) peculiarity.
- C) innovation.
- D) component.

15

It can most reasonably be inferred from the passage that a megacity's economic impact on a country is

- A) greater in countries with larger physical land areas.
- B) dependent on the types of companies located in the megacity.
- C) relatively equal for developing countries and high-income countries.
- D) neutralized by the economic cost of maintaining a megacity.

16

Which choice provides the best evidence for the answer to the previous question?

- A) lines 7-10 (“The studies . . . performance”)
- B) lines 30-32 (“While . . . not”)
- C) lines 48-51 (“This . . . economies”)
- D) lines 58-60 (“This . . . prosperity”)

17

The main purpose of the sixth paragraph (lines 52-60) is to

- A) provide an overview of existing megacities in high-income and developing countries.
- B) develop a claim about the effect of large cities in various parts of the world.
- C) identify a widely accepted theory about city size that future research should be able to confirm.
- D) compare causes of urbanization in the past with those in the present.

18

As used in line 69, “producing” most nearly means

- A) supplying.
- B) creating.
- C) directing.
- D) containing.

19

According to the graph, during what range of years did the median city population size in developing countries initially surpass that of high-income countries?

- A) 1965–1970
- B) 1980–1985
- C) 1990–1995
- D) 2005–2010

20

Which claim from the passage is best supported by the graph?

- A) The median population of cities in developing countries grew more sharply from 1960 to 2010 than did that of cities in high-income countries.
- B) In 1960, more than half of the countries with the largest average city size were high-income countries.
- C) The addition of 100,000 people in a large city causes an increase in economic growth in high-income countries but causes a decrease in economic growth in developing countries.
- D) Developing countries benefit from having more of the urban population living in smaller and medium-sized cities.

Questions 21-31 are based on the following passages.

Passage 1 is adapted from “Humans’ Big Brains May Be Partly due to Three Newly Found Genes.” ©2018 by Genetic Engineering & Biotechnology News. Passage 2 is adapted from Matt Wood, “Brain Size of Human Ancestors Evolved Gradually over 3 Million Years.” ©2018 by The University of Chicago Medical Center.

Passage 1

The brains of humans are conspicuously larger than the brains of other apes, but the human-specific genetic factors responsible for the uniquely large human neocortex remain obscure. Since humans split from chimps, which have brains roughly a third of human size, the human genome has undergone roughly 15 million changes. Which of these genetic tweaks could have led to big brains?

About six years ago, scientists in David Haussler’s lab at Howard Hughes Medical Institute discovered a gene called NOTCH2NL. It’s a relative of NOTCH2, a gene that scientists knew was central to early brain development. NOTCH2 controls vital decisions regarding when and how many neurons to make.

When the Haussler team looked in the official version of the human genome at that time¹—version 37—NOTCH2NL appeared to be located in chromosome 1 near a region linked to abnormal brain size. Delete a hunk of the region, and brains tend to shrink. Duplicate part of it, and brains tend to overgrow.

“We thought, ‘Oh, this is incredible,’” Haussler said. NOTCH2NL seemed to check all the boxes for a key role in human brain development. But when the team mapped NOTCH2NL’s precise location in the genome, they discovered the gene wasn’t actually in the relevant chromosomal region after all; the once-promising candidate seemed to be a dud.

“We were downhearted,” Haussler recalled. That all changed with the next official version of the human genome—version 38. In this iteration, NOTCH2NL was located in the crucial region. “And there were three versions of it,” Haussler exclaimed. Over the last three million years, his team calculated, NOTCH2NL was repeatedly copy-pasted into the genome, what he calls “a series of genetic accidents.”

Genetic analysis of several primate species revealed that the three genes exist only in humans and their recent relatives, the Neanderthals and Denisovans, not in chimpanzees, gorillas, or orangutans. What’s more, the timing of these genes’ emergence matches up with the period in the fossil record when our ancestors’ craniums began to enlarge, Haussler points out. Together, the results

suggest that NOTCH2NL genes played a role in beefing up human brain size.

Passage 2

Modern humans have brains that are more than three times larger than our closest living relatives, chimpanzees and bonobos. Scientists don’t agree on when and how this dramatic increase took place, but new analysis of 94 hominin fossils shows that average brain size increased gradually and consistently over the past three million years.

The research, published in *The Proceedings of the Royal Society B*, shows that the trend was caused primarily by evolution of larger brains within populations of individual species, but the introduction of new, larger-brained species and extinction of smaller-brained ones also played a part.

“Brain size is one of the most obvious traits that makes us human. It’s related to cultural complexity, language, tool making and all these other things that make us unique,” said Andrew Du, PhD, a postdoctoral scholar at the University of Chicago and first author of the study. “The earliest hominins had brain sizes like chimpanzees, and they have increased dramatically since then. So, it’s important to understand how we got here.”

Du and his colleagues compared published research data on the skull volumes of 94 fossil specimens from 13 different species, beginning with the earliest unambiguous human ancestors, *Australopithecus*, from 3.2 million years ago to pre-modern species, including *Homo erectus*, from 500,000 years ago when brain size began to overlap with that of modern-day humans.

The researchers saw that when the species were counted at the clade level, or groups descending from a common ancestor, the average brain size increased gradually over three million years. Looking more closely, the increase was driven by three different factors, primarily evolution of larger brain sizes within individual species populations, but also by the addition of new, larger-brained species and extinction of smaller-brained ones.

The study quantifies for the first time when and by how much each of these factors contributes to the clade-level pattern. Du said he likens it to how a football coach might build a roster of bigger, strong players. One way would be to make all the players hit the weight room to bulk up. But the coach could also recruit new, larger players and cut the smallest ones.

¹ The reference version of the human genome goes through updates to more completely map out each chromosomal sequence.

21

What does Passage 1 indicate is true of the human genome?

- A) It has gone through a large number of changes over time.
- B) It has nearly tripled in size in the last few million years.
- C) It contains many more genes than do the genomes of nonhuman primates.
- D) It retains only a few of the genes that were present in the genomes of Denisovans.

22

Based on Passage 1, what concept most likely contributed to Haussler’s team’s initial interest in NOTCH2NL?

- A) Similar genes often play different roles in the development of different species.
- B) A single gene typically has varying functions depending on where it is located in a genome.
- C) Genes that are near one another in a genome usually are duplicated at about the same rate.
- D) Genes that are related to one another tend to have comparable biological roles in development.

23

Which choice from Passage 1 provides the best evidence for the answer to the previous question?

- A) lines 11-14 (“It’s . . . make”)
- B) lines 18-20 (“Delete . . . overgrow”)
- C) lines 28-31 (“We were . . . region”)
- D) lines 31-35 (“And . . . accidents”)

24

Which choice from Passage 2 best supports the idea that brain size research may help answer important questions in realms beyond evolutionary biology?

- A) lines 47-51 (“Scientists . . . years”)
- B) lines 52-57 (“The research . . . part”)
- C) lines 58-63 (“Brain . . . study”)
- D) lines 66-72 (“Du . . . humans”)

25

As used in line 53, “trend” most nearly means

- A) inclination.
- B) custom.
- C) approach.
- D) progression.

26

The main purpose of the fifth paragraph of Passage 2 (lines 73-81) is to

- A) define a term that Du and his team introduced in their study.
- B) indicate the original objectives of Du’s team’s research.
- C) summarize the conclusions that Du and his team reached in their study.
- D) describe the methodologies used in Du’s team’s research.

27

In the context of Passage 2, the reference to a football coach in lines 84-88 (“Du . . . ones”) mainly serves to

- A) create a humorous image of the way Du and his team conducted their analyses.
- B) establish an analogy that illustrates the pattern Du and his team observed in their study.
- C) suggest that Du’s team’s findings may offer unexpected insights into everyday situations.
- D) convey that the primary factor Du’s team identified had some control over the other factors they studied.

28

Which choice best describes a key difference between the passages?

- A) Passage 1 refers only to data derived from computer simulations, while Passage 2 refers to data derived from simulations as well as from fossils.
- B) Passage 1 addresses genetic analyses of the brains of human ancestors only, while Passage 2 addresses genetic analyses of the brains of multiple primate species.
- C) Passage 1 limits its discussion to evolutionary changes in recent human history, while Passage 2 considers changes occurring over millennia.
- D) Passage 1 focuses on small-scale genetic changes that influenced brain evolution, while Passage 2 focuses on the influence of large-scale population-level changes.

29

Both passages state that the modern human brain is about three times larger than the brains of

- A) bonobos.
- B) chimpanzees.
- C) early hominins.
- D) Neanderthals.

30

As used in line 58, Passage 2, “obvious” is closest in meaning to which word as used in Passage 1?

- A) “conspicuously” (line 1)
- B) “vital” (line 13)
- C) “relevant” (line 25)
- D) “repeatedly” (line 34)

Questions 31-41 are based on the following passage.

This passage is adapted from a speech delivered by Tom Calma, "Still Riding for Freedom." ©2008 by Australian Human Rights Commission. Aboriginal Australians and the Torres Strait Islanders are the indigenous peoples of Australia.

For too long now, we have heard it argued that a focus on Aboriginal and Torres Strait Islander peoples' rights takes away from a focus on addressing Aboriginal and Torres Strait Islander peoples' disadvantage.

Line 5 This approach is, in my view, seriously flawed for a number of reasons. It represents a false dichotomy—as if poorer standards of health, lack of access to housing, lower attainment in education and higher unemployment are not human rights issues or somehow they don't relate to the cultural circumstances of Indigenous peoples.

And it also makes it too easy to disguise any causal relationship between the actions of government and any outcomes, and therefore limits the accountability and responsibilities of government.

15 In contrast, human rights give Aboriginal and Torres Strait Islander peoples a means for expressing their legitimate claims to equal goods, services, and most importantly, the protections of the law—and a standard that government is required to measure up to.

20 The focus on 'practical measures' was exemplified by the emphasis the previous federal government placed on the 'record levels of expenditure' annually on Indigenous issues.

25 As I have previously asked, since when did the size of the input become more important than the intended outcomes? The . . . government never explained what the point of the record expenditure argument was—or what achievements were made. . . .

30 And the fact is that there has been no simple way of being able to decide whether the progress made through 'record expenditure' has been 'good enough'. So the 'practical' approach to these issues has lacked any accountability whatsoever. . . .

35 If we look back over the past five years in particular . . . we can also see that a 'practical' approach to issues has allowed governments to devise a whole series of policies and programs without engaging with Indigenous peoples in any serious manner. I have previously described this as the 'fundamental flaw' of the federal government's efforts over the past five years. That is, government policy that is applied to Indigenous peoples as passive recipients.

Our challenge now is to redefine and understand these issues as human rights issues.

45 We face a major challenge in 'skilling up' government and the bureaucracy so that they are capable of utilising

human rights as a tool for best practice policy development and as an accountability mechanism.

. . . In March this year, the Prime Minister, the Leader of the Opposition, Ministers for Health and Indigenous Affairs, every major Indigenous and non-Indigenous peak health body and others signed a Statement of Intent to close the gap in health inequality which set out how this commitment would be met. It commits all of these organisations and government, among other things, to:

- 55 • develop a long-term plan of action, that is targeted to need, evidence-based and capable of addressing the existing inequities in health services, in order to achieve equality of health status and life expectancy between Aboriginal and Torres Strait Islander peoples and non-Indigenous Australians by 2030.
- 60 • ensure the full participation of Aboriginal and Torres Strait Islander peoples and their representative bodies in all aspects of addressing their health needs.
- 65 • work collectively to systematically address the social determinants that impact on achieving health equality for Aboriginal and Torres Strait Islander peoples.
- 70 • respect and promote the rights of Aboriginal and Torres Strait Islander peoples, and
- measure, monitor, and report on our joint efforts, in accordance with benchmarks and targets, to ensure that we are progressively realising our shared ambitions.

75 These commitments were made in relation to Indigenous health issues but they form a template for the type of approach that is needed across all areas of poverty, marginalisation and disadvantage experienced by Indigenous peoples.

80 They provide the basis for the cultural shift necessary in how we conceptualise human rights in this country. Issues of entrenched and ongoing poverty and marginalisation of Indigenous peoples are human rights challenges. And we need to lift our expectations of what needs to be done to address these issues and of what constitutes sufficient progress to address these issues in the shortest possible timeframe so that we can realise a vision of an equal society.

31

One central theme of the passage is that

- A) expanding legal rights of citizens will not necessarily improve national health outcomes.
- B) human rights initiatives should generally receive more funding than health initiatives do.
- C) human rights should be used as a framework for government policy on indigenous issues.
- D) focusing on indigenous peoples' rights detracts from the more practical concerns of indigenous communities.

32

According to Calma, the government's failure to link its expenditures on indigenous health initiatives to specific health outcomes is harmful because it

- A) reinforces negative attitudes about the government's financial fitness.
- B) undermines efforts to standardize practices across all departments of the government.
- C) perpetuates the pattern of government officials abusing their authority.
- D) allows the government to evade the obligation to be answerable for its policies.

33

Calma indicates that in the past, the Australian government stressed which aspect of its relationship to indigenous peoples?

- A) The willingness it has shown to meet with indigenous leaders
- B) The regret it has expressed for the injustices it committed against indigenous peoples
- C) The improvements it has made in indigenous peoples' living standards
- D) The financial resources it has devoted to indigenous issues

34

As used in line 30, "decide" most nearly means

- A) accept.
- B) choose.
- C) determine.
- D) wonder.

35

Based on the passage, Calma would most likely agree that programs related to indigenous issues would have a better chance of succeeding if the Australian government

- A) empowered indigenous communities to assist in devising and implementing such programs.
- B) funded such programs as generously as it funds programs benefiting nonindigenous people.
- C) modeled such programs on health-care initiatives that have a proven record of success.
- D) devoted as many resources to such programs as the previous government did.

36

Which choice provides the best evidence for the answer to the previous question?

- A) lines 15-19 ("In contrast . . . up to")
- B) lines 24-28 ("As I . . . made")
- C) lines 38-41 ("I have . . . recipients")
- D) lines 75-79 ("These . . . peoples")

37

Beginning with the ninth paragraph (lines 42-88), the focus of the passage shifts from

- A) a description of conditions in indigenous communities to recommendations for improving those conditions.
- B) criticism of the Australian government's past approach to indigenous issues to an outline of its new approach.
- C) condemnation of officials' indifference toward indigenous concerns to a proposal to address those concerns.
- D) a discussion of tensions between the Australian government and indigenous groups to a suggestion of how those tensions can be resolved.

38

The list in lines 55-74 ("develop . . . ambitions") mainly serves to

- A) summarize actions specified in the Statement of Intent.
- B) propose modifications to the Statement of Intent.
- C) enumerate similarities between the Statement of Intent and past agreements.
- D) identify certain inconsistencies in the Statement of Intent.

39

As used in line 72, "targets" most nearly means

- A) centers.
- B) goals.
- C) subjects.
- D) prey.

40

Based on the passage, Calma regards the audience of his speech as being

- A) skeptical that the specific individuals responsible for the government's failed policies on indigenous issues will be held accountable.
- B) poorly informed about the economic and social conditions found in most indigenous communities.
- C) doubtful of the value of discussing indigenous issues within the larger context of human rights.
- D) overly tolerant of the fact that government initiatives to address the inequality faced by indigenous peoples have not succeeded

41

Which choice provides the best evidence for the answer to the previous question?

- A) lines 42-43 ("Our . . . issues")
- B) lines 44-47 ("We face . . . mechanism")
- C) lines 80-84 ("They . . . challenges")
- D) lines 84-88 ("And we . . . society")

Questions 42-52 are based on the following passage and supplementary material.

This passage is adapted from John Chambers and Jacqueline Mitton, *From Dust to Life: The Origin and Evolution of Our Solar System*. ©2014 by John Chambers and Jacqueline Mitton. Differentiated asteroids are made up of layers of different material, such as an iron core, a rocky mantle, and a thin volcanic crust. Primitive asteroids are undifferentiated asteroids that are thought to have changed little since they formed.

Scientists believe that iron meteorites come from the cores of asteroids that melted. But what happened to the corresponding rocky material that formed the mantles of these bodies? A few asteroids have spectra¹ that match those of mantle rocks, but they are very rare. Some nonmetallic meteorites come from asteroids that have partially or wholly melted, but these do not match the minerals we would expect to see in the missing mantles of the iron parent bodies. These exotic meteorites must come from some other kind of parent body instead.

The rarity of mantle rocks in our meteorite collection and in the asteroid belt, known as the “missing mantle problem,” is a long-standing puzzle. There are several reasons why iron fragments might survive better than rocky fragments when asteroids break apart. Iron lies in the core of a differentiated asteroid, while rocky material lies near the surface. Thus, rocky material will be the first to be removed when an asteroid is bombarded, while iron is the last to be exposed. As a result, rocky fragments have to survive in space for longer than iron ones. Most of the rocky mantle may be peeled away in small fragments—chips from the surface—while the iron core remains as a single piece, making it harder to disrupt later. Last and most important, iron is much stronger than rock: a piece of iron is likely to survive in the asteroid belt at least 10 times longer than a rocky fragment of the same size.

If most differentiated bodies broke apart early in the solar system, perhaps all the mantle material has been ground down to dust and lost over the billions of years since then. This would mean that intact differentiated asteroids are very rare in the asteroid belt today. Perhaps Vesta [a differentiated asteroid with a diameter of more than 300 miles] and a handful of others are all that remain.

However, collisional erosion cannot be the whole story. Primitive asteroids, the parent bodies of chondritic meteorites [the most common type of

meteorite found on Earth], are no stronger than the mantle rocks from differentiated asteroids. How did so many primitive asteroids survive when almost none of the differentiated ones did? Part of the explanation may simply be that differentiated bodies were relatively rare to begin with and none have survived. Still, if almost all differentiated bodies were destroyed in violent collisions, how did Vesta survive with only a single large crater on its surface?

Astronomer William Bottke and his colleagues recently came up with a possible explanation: perhaps the parent bodies of the iron meteorites formed closer to the Sun, in the region that now contains the terrestrial planets. Objects would have been more tightly packed nearer the Sun, so collisions would have been more frequent than in the asteroid belt. Many, perhaps most, differentiated bodies were disrupted by violent collisions. Gravitational perturbations from larger bodies scattered some of these fragments into the asteroid belt. Both iron and rocky fragments arrived in the asteroid belt, but only the stronger iron objects have survived for the age of the solar system. Later on, the parent bodies of primitive meteorites formed in the asteroid belt. Most of these objects survived, leaving an asteroid belt today that is a mixture of intact primitive bodies and fragments of iron.

¹ Characteristic wavelengths of light that asteroids reflect

Composition of Asteroid Belt by Asteroid Type, with and without Four Largest Asteroid Belt Objects			
Asteroid type	Description	Portion of belt's total mass (%)	
		All objects in the belt	All objects in the belt but the four largest
A	likely from mantles of differentiated asteroids	0.37	0.37
B	contain carbon, low reflectivity	11.10	3.55
C	contain carbon, possibly parents of chondritic meteorites, primitive	52.53	14.41
D	low reflectivity, composition little known, primitive	2.03	2.03
K	possibly carbon rich, may be parents of some carbonaceous meteorites	0.95	0.95
L	similar to some chondritic meteorites, may be primitive	0.68	0.68
S	contain silicates and iron, possibly parents of some chondritic meteorites	8.41	8.41
V	mainly Vesta and related asteroids, basaltic	9.59	0.01
E	relatively high reflectivity, variety of compositions	0.05	0.05
M	moderate reflectivity, possibly represent the metallic (iron) cores of formerly differentiated bodies	3.26	3.26
P	thought to be primitive, rich in carbon, possibly linked to some chondritic meteorites	11.02	11.02
Sum (nearest percent)		100	45

Adapted from F. E. DeMeo and B. Carry, "The Taxonomic Distribution of Asteroids from Multi-Filter All-Sky Photometric Surveys." ©2013 by Elsevier Inc.

42

The main purpose of the passage is to

- A) discuss a study intended to explain the high number of meteorites on Earth that have come from primitive asteroids.
- B) describe competing hypotheses about the conditions under which primitive asteroids initially formed.
- C) present a scientific debate about the prevalence of differentiated asteroids in the asteroid belt in the early solar system.
- D) account for the scarcity of a component of differentiated asteroids in the asteroid belt and among meteorites on Earth.

43

As used in line 25, "disrupt" most nearly means

- A) fracture.
- B) confuse.
- C) interrupt.
- D) impede.

44

The passage most strongly suggests that if collisional erosion within the asteroid belt was sufficient to explain the situation discussed in the passage, then, as a result, scientists would expect to find that

- A) Vesta is not the only large differentiated asteroid in the asteroid belt.
- B) the asteroid belt has far fewer primitive asteroids than it currently does.
- C) iron fragments in the asteroid belt tend to be smaller than rocky fragments in the asteroid belt.
- D) there were originally about as many primitive asteroids as differentiated asteroids in the asteroid belt.

45

Which choice provides the best evidence for the answer to the previous question?

- A) lines 35-37 (“Perhaps . . . remain”)
- B) lines 38-39 (“However . . . story”)
- C) lines 39-44 (“Primitive . . . did”)
- D) lines 44-47 (“Part . . . survived”)

46

The question in lines 47-49 (“Still . . . surface”) mainly serves to

- A) highlight an anomaly that challenges an idea presented earlier in the passage.
- B) present a hypothesis tested by scientists who are introduced later in the passage.
- C) cast doubt on the likelihood that the central problem discussed in the passage will be resolved.
- D) point out the lack of observational data concerning a particular asteroid discussed in the passage.

47

As used in lines 53-54, “contains” most nearly means

- A) controls.
- B) embodies.
- C) encompasses.
- D) restrains.

48

According to the passage, Bottke and his colleagues explain the presence of iron fragments in the asteroid belt by asserting that the fragments were

- A) remnants of differentiated asteroids that were destroyed in collisions in the asteroid belt.
- B) created relatively close to the Sun and ended up in the asteroid belt due to the gravity of large objects.
- C) formed on terrestrial planets and ejected into the asteroid belt by collisions with primitive asteroids.
- D) formed in the region of the terrestrial planets but knocked into the asteroid belt by collisions with the parent bodies of primitive asteroids.

49

Data in the table best support the conclusion that the majority of the mass in the asteroid belt as a whole is in asteroids that are

- A) primitive.
- B) basaltic.
- C) high in reflectivity.
- D) low in reflectivity.

50

Assuming that the four largest asteroid belt objects are among the 11 listed asteroid types, which statement about those asteroids is best supported by data in the table?

- A) None of them is type V.
- B) None of them is likely to contain carbon.
- C) One of them is type K.
- D) Two of them are the same type.

51

Taken together, the passage and the table most strongly suggest that the model proposed by some astronomers would imply which conclusion about type C asteroids?

- A) They come from type S asteroids that melted.
- B) They once comprised a smaller portion of the asteroid belt than type V asteroids did.
- C) They have experienced fewer collisions than have type L asteroids.
- D) They are younger than are type M asteroids.

52

Which choice provides the best evidence for the answer to the previous question?

- A) lines 1-2 (“Scientists . . . melted”)
- B) lines 17-18 (“Iron . . . surface”)
- C) lines 30-35 (“If most . . . today”)
- D) lines 60-64 (“Both . . . belt”)

STOP

**If you finish before time is called, you may check your work on this section only.
Do not turn to any other section.**

No Test Material On This Page

Writing and Language Test

35 MINUTES, 44 QUESTIONS

Turn to Section 2 of your answer sheet to answer the questions in this section.

DIRECTIONS

Each passage below is accompanied by a number of questions. For some questions, you will consider how the passage might be revised to improve the expression of ideas. For other questions, you will consider how the passage might be edited to correct errors in sentence structure, usage, or punctuation. A passage or a question may be accompanied by one or more graphics (such as a table or graph) that you will consider as you make revising and editing decisions.

Some questions will direct you to an underlined portion of a passage. Other questions will direct you to a location in a passage or ask you to think about the passage as a whole.

After reading each passage, choose the answer to each question that most effectively improves the quality of writing in the passage or that makes the passage conform to the conventions of standard written English. Many questions include a "NO CHANGE" option. Choose that option if you think the best choice is to leave the relevant portion of the passage as it is.

Questions 1-11 are based on the following passage and supplementary material.

The Lemur's Unique Traits

The often striped tail of the lemur, a primate found only on the island nation of Madagascar, is just one of this animal's unique qualities. While most primates eat only during the day, the lemur eats during the day and at night, **1** and while most primates primarily eat fruit, the lemur primarily eats leaves. A 2017 study conducted by an international team of scientists **2** suggest that a lack of nitrogen in Madagascar's fruits may have caused the lemur to develop these unusual feeding traits through evolution.

1

- A) NO CHANGE
- B) which
- C) so
- D) DELETE the underlined portion.

2

- A) NO CHANGE
- B) suggests
- C) have suggested
- D) are suggesting

Nitrogen, a key element found in all proteins, is one of the most important factors in any animal's 3 survival. It is important because proteins are used for functions such as building muscle and moving oxygen through the bloodstream. Many primates 4 obtain a large proportion of their dietary nitrogen from fruit, so the researchers suspected that Madagascar's fruit had insufficient levels of nitrogen for the lemur; without it, lemurs' bodies cannot synthesize enough protein to live. To get an answer, the scientists tested the levels of nitrogen in fruit from multiple primate habitats.

Sites were chosen in continental 5 Africa; South America, and Madagascar because primate families in these locations all have the same relative nitrogen requirements. At the continental African sites in Uganda and Cameroon, 6 however, the scientists found fruit to have nitrogen concentrations of 1.53 percent and 1.44 percent, respectively. The South American sites yielded similar results, with nitrogen concentrations in fruit

3

Which choice most effectively combines the sentences at the underlined portion?

- A) survival; the importance is that
- B) survival, and it is because
- C) survival, important since
- D) survival, as

4

- A) NO CHANGE
- B) get a bunch
- C) bring in lots
- D) procure a preponderance

5

- A) NO CHANGE
- B) Africa, South America, and Madagascar
- C) Africa, South America, and, Madagascar
- D) Africa South America, and Madagascar;

6

- A) NO CHANGE
- B) likewise,
- C) therefore,
- D) DELETE the underlined portion.

Mean Nitrogen Concentrations in Fruit from Selected Sites with Primate Populations

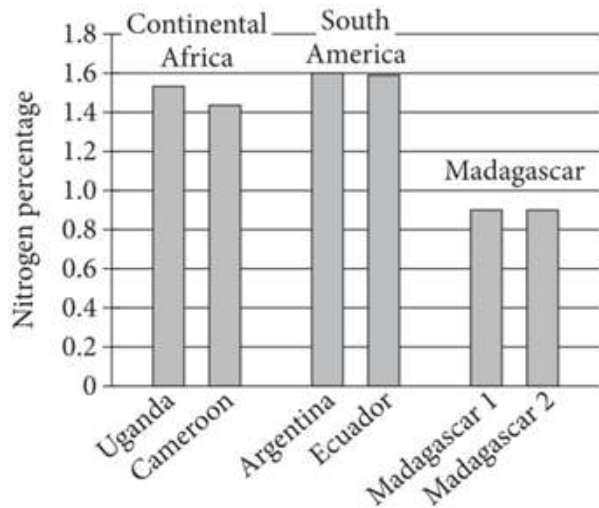

Source: Data from Giuseppe Donati et al., “Low Levels of Fruit Nitrogen as Drivers for the Evolution of Madagascar’s Primate Communities.” ©2017 by Giuseppe Donati et al.

of 1.60 percent in **7** Ecuador and 1.30 percent in Argentina. Madagascar’s levels, however, were lower:

8 fruit selected from one site there showed a nitrogen concentration of only 0.6 percent. Although it remains unclear if primates in areas other than Madagascar acquire all the nitrogen they need by eating fruit, the researchers knew from prior studies that fruit with a nitrogen concentration of 0.9 percent is below the minimum amount of nitrogen (1.1 percent) that a primate requires.

7

Which choice provides accurate information from the graph?

- A) NO CHANGE
- B) Argentina, Ecuador, and one site in Madagascar.
- C) Argentina and 1.59 percent in Ecuador.
- D) Argentina and less than 1 percent in Ecuador.

8

Which choice most accurately reflects the information provided in the graph?

- A) NO CHANGE
- B) the fruit selected from there showed nitrogen concentrations that were lower than those at the South American sites but similar to those found at the continental African sites.
- C) fruit selected from two sites there both showed nitrogen concentrations of 0.9 percent.
- D) none of the fruit selected from there showed nitrogen concentrations above 0.8 percent.

[1] These data indicated to scientists that the lower levels of nitrogen in Madagascar’s fruit **9** likely forced the lemurs to start eating nitrogen-rich leaves so that their bodies could synthesize protein. [2] In addition, the lemur’s tendency to eat both day and night may be an adaptation it developed due to limited nitrogen: lemurs may need to eat for more hours per day to meet their dietary needs. [3] As Abigail Derby Lewis, one of the **10** studies’ ecologists’, says, “Knowing how and why they evolved in the direction they have—from their diet, to social structure and cognition—is crucial in helping to inform effective conservation approaches.” **11**

9

- A) NO CHANGE
- B) likely force
- C) will likely force
- D) are likely forcing

10

- A) NO CHANGE
- B) study’s ecologists,
- C) study’s ecologist’s,
- D) studies ecologists,

11

The writer wants to add the following sentence to this paragraph.

Both unique traits have key implications for protecting these endangered primates.

The best placement for the sentence is

- A) before sentence 1.
- B) after sentence 1.
- C) after sentence 2.
- D) after sentence 3.

Questions 12-22 are based on the following passage.

Bicycling in the Netherlands

Approximately 22,000 miles of bicycle paths crisscross the Netherlands, making cycling in and between Dutch cities safe and convenient. In fact, according to the European Cyclists' Federation, the Netherlands is one of the two most bike friendly countries in Europe (sharing top honors with Denmark). While the Netherlands is well known as a cycling hub, less well known is how **12** was that reputation earned? Persistent activism over many years was instrumental to the enduring popularity of cycling among the Dutch.

In the early twentieth century, the Dutch were cycling **13** enthusiasts, not only riding but also manufacturing bicycles in large numbers. Cycling made sense in the flat, densely populated country. As personal income grew in the postwar boom years of the 1950s and 1960s, **14** in short, car ownership rose sharply, and cars began to eclipse bikes in popularity. Along with more cars came an alarming spike in traffic accidents on narrow streets not designed to accommodate large numbers of cars. **15**

12

- A) NO CHANGE
- B) that reputation was earned?
- C) that reputation was earned.
- D) was that reputation earned.

13

- A) NO CHANGE
- B) enthusiasts, they were not only riding
- C) enthusiasts. Not only riding,
- D) enthusiasts; who were not only riding,

14

- A) NO CHANGE
- B) in other words,
- C) therefore,
- D) however,

15

At this point, the writer is considering adding the following sentence.

One type of bicycle popular with the Dutch was known as a “grandma bike” (omafiets).

Should the writer make this addition here?

- A) Yes, because it gives a specific example of a type of bicycle manufactured in the Netherlands.
- B) Yes, because it helps illustrate the idea that the streets were more suitable for bicycles than for cars.
- C) No, because it blurs the paragraph's focus on the history of cycling in the Netherlands.
- D) No, because it doesn't sufficiently support the claim that the omafiets was popular.

[1] By the 1970s, concerned citizens started organizing demonstrations to promote safety for cyclists and pedestrians. [2] They declared car-free holidays, closing off streets and hosting street parties. [3] They organized mass bike rides. [4] They wrote protest songs and serenaded the prime minister outside his **16** resident's. [5] Tom Godefrooij, a longtime member of the Dutch Cyclists' **17** Union (Fietzersbond), recalls that the activists' efforts often led to good publicity. [6] "We had a great fighting spirit and we knew how to voice our ideas," he recounted in a 2015 interview. **18**

16

- A) NO CHANGE
- B) residents.
- C) residence.
- D) residents'.

17

- A) NO CHANGE
- B) Union (Fietzersbond)
- C) Union, (Fietzersbond),
- D) Union, (Fietzersbond)

18

The writer plans to add the following sentence to this paragraph.

These citizens expressed their serious concerns using various inventive, sometimes playful tactics.

The best placement for the sentence is

- A) after sentence 1.
- B) after sentence 2.
- C) after sentence 3.
- D) after sentence 5.

As the 1980s approached, local governments began to respond to the demonstrations by Fietsersbond and other groups by funding projects to improve the nation’s cycling 19 infrastructure. As a result of the improved infrastructure, more people were encouraged to use bicycles as their primary means of transportation. The improvements made cycling easier and safer. 20 Some funding came from private donors. Bike lanes and racks appeared on city streets, many of which featured speed bumps and turns that forced cars to drive 21 more slowly than they would on streets without those features and to yield.

Promoting cycling continues to be a national priority in the twenty-first century, and the Dutch government often partners with cycling organizations to craft policies that improve access and safety for cyclists. But challenges remain. Fietsersbond, now more than 34,000 members 22 of strongness, continues to advocate for the cycling community. “The battle goes on,” says Godefrooij. “We’ve come a long way, but we can never lower our guard.”

19

Which choice most effectively combines the sentences at the underlined portion?

- A) infrastructure; in addition, more people were encouraged
- B) infrastructure, and along with the improvements came the encouragement of more people
- C) infrastructure, which was accompanied by more people being encouraged
- D) infrastructure, which in turn encouraged more people

20

Which choice provides a supporting example most similar to the other examples in the paragraph?

- A) NO CHANGE
- B) Fietsersbond and its allies had many other successes.
- C) Cycling was preferred to driving by a large number of commuters.
- D) Bicycle paths were clearly marked, well maintained, and well lit.

21

- A) NO CHANGE
- B) slowly in the streets and yield.
- C) slowly and yield to cyclists.
- D) slowly and forced them to yield to cyclists.

22

- A) NO CHANGE
- B) strong,
- C) strengthened,
- D) of strength,

Questions 23-33 are based on the following passage.

The Mysterious Women of Delirious Matter

Discussing her 2018 sculpture installation *Delirious Matter* with a reporter, Diana Al-Hadid **23** made a statement about art’s “old masters.” She stated that these artists, who were exclusively men, often portrayed women as “either encased in a giant pile of fabric or lounging horizontally.” To Al-Hadid, **24** they reveal a lot about the role of women in precontemporary art: **25** women were goddesses, objects of desire, or both. In her own installation, she asks viewers to reassess these stereotypical representations, particularly classical Greek and Roman ones, through her clever use of abstractions and visual illusions.

These techniques are displayed vividly in *Delirious Matter*’s three life-size female figures, which, like many classical Greek sculptures of women, are seated or lying down as if waiting for someone. The figures are headless, an abstraction that echoes famous ancient works such as the armless statue *Venus de Milo* and emphasizes the centrality of the body (over the mind) in traditional sculptures of women. **26** Rather, the figures are incomplete shells, which Al-Hadid constructed by

23

Which choice most effectively combines the sentences at the underlined portion?

- A) stated that art’s “old masters,”
- B) made a statement that art’s “old masters,”
- C) stated that artists who were “old masters,”
- D) made a statement: “old master” artists, she stated,

24

- A) NO CHANGE
- B) it reveals
- C) these men reveal
- D) these depictions reveal

25

The writer is considering deleting the underlined portion, adjusting the punctuation as needed. Should the underlined portion be kept or deleted?

- A) Kept, because it elaborates on the information provided in the first part of the sentence.
- B) Kept, because it explains that women can be portrayed in multiple ways.
- C) Deleted, because it is irrelevant to the main idea of the passage.
- D) Deleted, because it misrepresents Al-Hadid’s statement provided in the previous sentence.

26

- A) NO CHANGE
- B) For example,
- C) Additionally,
- D) Consequently,

pouring a gypsum-polymer mixture over a mold of a female form, letting the mixture drip down in streaks, and then **27** the mold was removed. Many of the solidified streaks do not connect, **28** allowing viewers to see through the figures, creating the illusion that they are intangible. Finally, the plinths the figures rest on are also made of isolated, incomplete streaks, giving the impression that the figures are floating in midair.

29 A female figure is depicted in Delirious Matter's similarly drippy, lacelike, 14-foot-tall sculpture *Gradiva*, which alludes to Wilhelm Jensen's 1902 novella of the same name. In the novella, a male archaeologist becomes so infatuated with the "maidenly grace" of a well-known Roman sculpture of a woman, whom he calls *Gradiva*, that he begins to hallucinate that she is alive. The archaeologist's idealizations of and delusions about *Gradiva* are represented in Al-Hadid's wall-like sculpture: its disconnected streaks make it hard for viewers to identify the subtle image of *Gradiva*. By obscuring the image, Al-Hadid **30** asks viewers of the image to wonder whether or not they are actually seeing *Gradiva*. This formlessness of Al-Hadid's *Gradiva* then points to the limitations of the Roman *Gradiva*: she was

27

- A) NO CHANGE
- B) removing the mold.
- C) she removed the mold.
- D) there was the mold's removal.

28

Which choice describing an effect of the sculpture's streaks best supports the main idea of the passage?

- A) NO CHANGE
- B) making the female figures as mysterious to viewers today as they would have been to the Greeks.
- C) creating spaces in between them, some narrow, some wide.
- D) showcasing a fragmented style that was common in twentieth-century modern art.

29

Which choice provides the best transition from the previous paragraph to this one?

- A) NO CHANGE
- B) One enchanting piece in *Delirious Matter* is the
- C) Among the headless women of *Delirious Matter* stands the
- D) Al-Hadid incorporated fiberglass to create *Delirious Matter's*

30

- A) NO CHANGE
- B) makes viewers wonder if
- C) creates a situation in which her viewers wonder if
- D) makes the image's viewers wonder whether

a fantasy, unrealistic and objectified. **31** Wasn't there more to the Roman woman than her "maidenly grace."

Although the fact that Delirious Matter's sculptures are fragmentary and porous **32** create the illusion that they are delicate objects, it also suggests that their female subjects have escaped to transcend their original forms. If the women have **33** escaped, perhaps it is to take their places as viewers, or even as the artist herself.

31

- A) NO CHANGE
- B) There wasn't more to the Roman woman? Than her "maidenly grace"?
- C) Wasn't there more to the Roman woman. Than her "maidenly grace."
- D) Wasn't there more to the Roman woman than her "maidenly grace"?

32

- A) NO CHANGE
- B) creates
- C) have created
- D) are creating

33

- A) NO CHANGE
- B) escaped. Perhaps
- C) escaped then perhaps
- D) escaped, and perhaps

Questions 34-44 are based on the following passage and supplementary material.

Kitchen Incubators: Cooking Up Opportunities

— 1 —

Kitchen incubators, as the term suggests, help establish and nurture new food businesses. In exchange for **34** unimportant fees, kitchen incubators provide would-be entrepreneurs with the facilities, training, and customers they need to succeed. **35** Anyone, interested in starting a food business, would be wise to consider working with a kitchen incubator.

— 2 —

While the cost of building and equipping a commercial kitchen is prohibitive for most new businesses, incubators offer their members the use of fully equipped kitchens at affordable hourly rates. At Micro Mercantes in Portland, Oregon, for instance, **36** there is a tortilla press, a rice cooker, and a variety of pots and pans. The kitchen facilities are in use more than 150 hours per week. High demand for kitchen space at Micro Mercantes and other incubators demonstrates that entrepreneurs value this service.

— 3 —

Kitchen incubators also assist business owners by offering classes on subjects such as food safety, budgeting, and recipe scaling. Maria Lizama credits Micro Mercantes classes with preparing her to open a food truck from which to sell pupusas, a traditional dish

34

- A) NO CHANGE
- B) petty
- C) imperceptible
- D) nominal

35

- A) NO CHANGE
- B) Anyone interested in starting a food business
- C) Anyone interested, in starting a food business,
- D) Anyone interested in starting a food business,

36

Which choice most effectively elaborates on the information provided earlier in the paragraph?

- A) NO CHANGE
- B) the money from kitchen rentals is used to maintain facilities and invest in new equipment.
- C) more than thirty artists and performers entertain shoppers in the adjacent market.
- D) more than forty different start-ups pay a modest fee to rent kitchen space.

of her native El Salvador. The training she received at Micro Mercantes helped Lizama in many aspects of her business, including **37** the aspect of developing a marketing plan and hiring the right employees.

— 4 —

Many kitchen incubators provide access to another necessary component of a **38** successful—business—customers. For example, Hope & Main, based in Warren, Rhode Island, hosts a market where customers try free samples of treats like pralines, pimento cheese, and rugelach—all made by vendors using the incubator’s kitchens—before they buy. Hope & Main’s founder and president Lisa Raiola says customers provide valuable feedback to vendors. “We have had many companies crowdsource and perfect their recipes, packaging, and branding,” she explains.

37

- A) NO CHANGE
- B) developing and devising a marketing plan
- C) helping Lizama develop a marketing plan for her business
- D) developing a marketing plan

38

- A) NO CHANGE
- B) successful business: customers.
- C) successful business customers.
- D) successful business; customers.

— 5 —

The growth of kitchen incubators is a testament to **39** its importance to burgeoning small businesses. A 2016 industry report notes that the number of kitchen incubators increased more than 50% from 2013 to 2016. A survey published in the report shows that most incubators surveyed (53%) **40** experienced growth during that time. While profits were paramount to 17% of incubators, others indicated that strengthening the local food economy (12%), helping people in need (5%), and building community (5%) were primary concerns.

Kitchen Incubator Survey Responses*

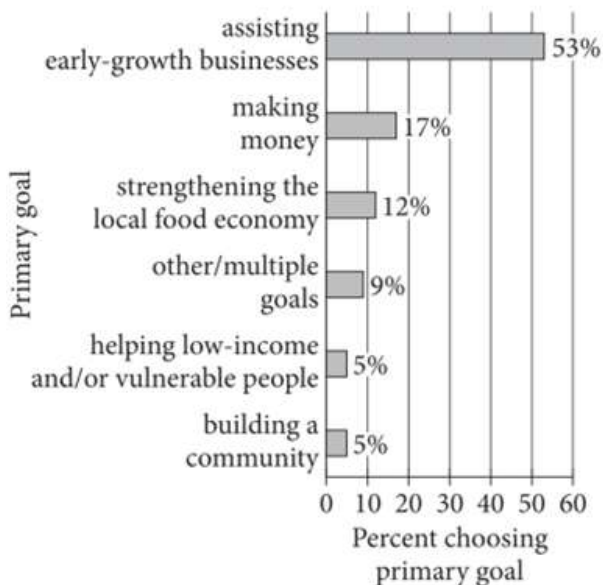

*Sixty-one kitchen incubators responded to the question “How would you describe the primary goal of your facility?”

Adapted from Adam Wodka et al., U.S. Kitchen Incubators: An Industry Update. ©2016 by American Communities Trust, Econsult Solutions, Urbane Development.

39

- A) NO CHANGE
- B) it’s
- C) they’re
- D) their

40

Which choice most accurately and effectively incorporates information from the graph?

- A) NO CHANGE
- B) were mainly concerned with supporting their members.
- C) had more than one primary purpose.
- D) shared the same goal.

— 6 —

The food industry is very competitive, and **41** consumers' tastes are notoriously fickle. **42** In addition, entrepreneurs who make the small monetary investment that kitchen incubators require find **43** them and their fledgling food businesses well positioned to succeed.

41

- A) NO CHANGE
- B) consumer's tastes
- C) consumers' tastes'
- D) consumer's taste's

42

- A) NO CHANGE
- B) Conversely,
- C) Still,
- D) Therefore,

43

- A) NO CHANGE
- B) it
- C) themselves
- D) itself

44

The writer wants to add the following sentence to the passage.

Kitchen incubators can't guarantee success, of course.

The most logical placement for the sentence is at the beginning of

- A) paragraph 2.
- B) paragraph 4.
- C) paragraph 5.
- D) paragraph 6.

STOP

**If you finish before time is called, you may check your work on this section only.
Do not turn to any other section.**



Math Test – No Calculator

25 MINUTES, 20 QUESTIONS

Turn to Section 3 of your answer sheet to answer the questions in this section.

DIRECTIONS

For questions 1-15, solve each problem, choose the best answer from the choices provided, and fill in the corresponding circle on your answer sheet. For questions 16-20, solve the problem and enter your answer in the grid on the answer sheet. Please refer to the directions before question 16 on how to enter your answers in the grid. You may use any available space in your test booklet for scratch work.

NOTES

- The use of a calculator **is not permitted**.
- All variables and expressions used represent real numbers unless otherwise indicated.
- Figures provided in this test are drawn to scale unless otherwise indicated.
- All figures lie in a plane unless otherwise indicated.
- Unless otherwise indicated, the domain of a given function f is the set of all real numbers x for which $f(x)$ is a real number.

REFERENCE

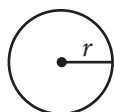

$$A = \pi r^2$$

$$C = 2\pi r$$

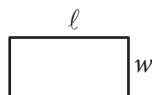

$$A = \ell w$$

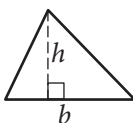

$$A = \frac{1}{2}bh$$

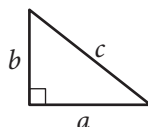

$$c^2 = a^2 + b^2$$

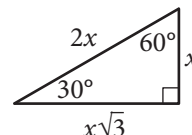

Special Right Triangles

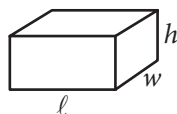
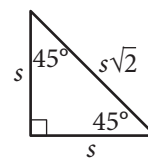

$$V = \ell wh$$

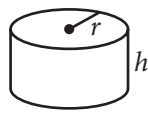

$$V = \pi r^2 h$$



$$V = \frac{4}{3}\pi r^3$$

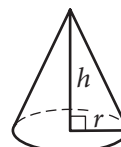

$$V = \frac{1}{3}\pi r^2 h$$



$$V = \frac{1}{3}\ell wh$$

The number of degrees of arc in a circle is 360.

The number of radians of arc in a circle is 2π .

The sum of the measures in degrees of the angles of a triangle is 180.



1

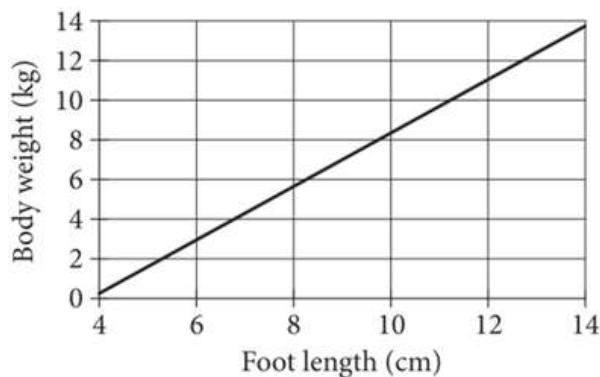

The line models the relationship between body weight and foot length for a group of infants. Based on the model, what is the predicted weight, in kilograms (kg), of an infant with a foot length of 9 centimeters (cm)?

- A) 5
- B) 7
- C) 9
- D) 11

2

Line segment AC has a length of 120 and contains point B . If $AB = 5x + 20$ and $BC = 6x - 10$, which equation shows the relationship between the lengths of line segments AB , BC , and AC ?

- A) $5x + 20 = 120$
- B) $6x - 10 = 120$
- C) $(5x + 20) - (6x - 10) = 120$
- D) $(5x + 20) + (6x - 10) = 120$

3

$$x = 4$$

$$y = \frac{x}{4} + 2$$

What is the solution (x,y) to the given system of equations?

- A) (4,6)
- B) (4,3)
- C) (4,2)
- D) (4,1)



4

The function f is defined by $f(x) = 2x + 6$. What is the graph of $y = f(x)$?

A)

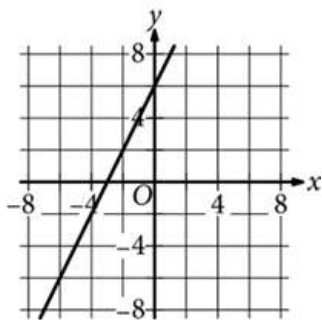

B)

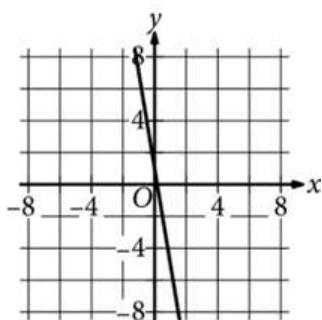

C)

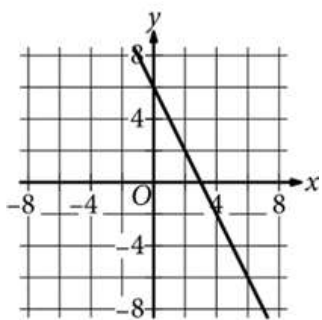

D)

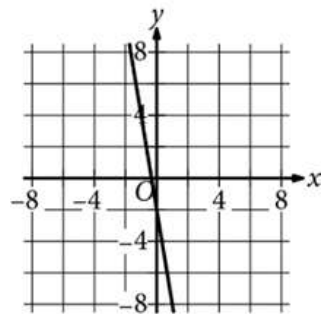

5

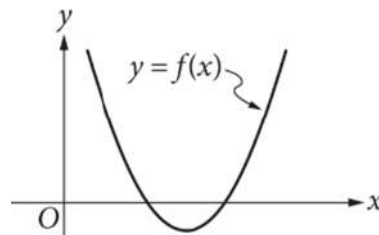

The graph of the quadratic function f is shown, where $y = f(x)$. Which of the following could be the graph of $y = f(x) + 2$?

A)

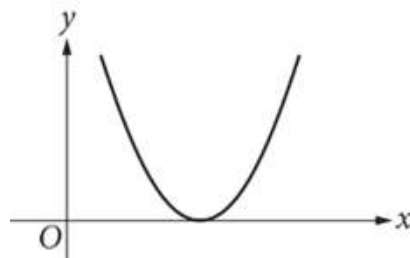

B)

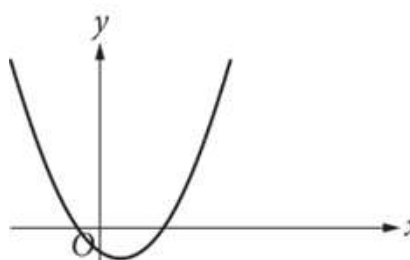

C)

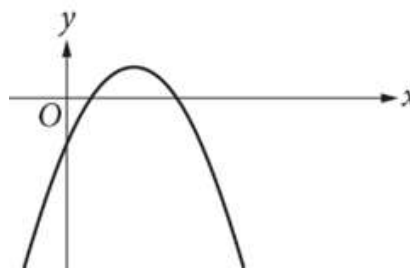

D)

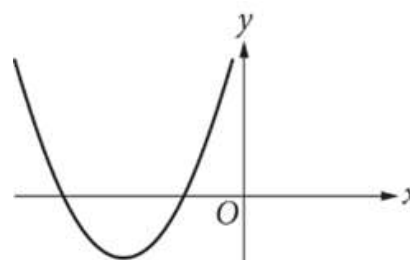



6

The function q is defined by $q(x) = 5(-1)^x$, where x is an integer. What is the value of $q(6)$?

- A) -30
- B) -5
- C) 5
- D) 30

7

$$\frac{(x-4)(x+2)}{(x-4)} = 0$$

Which value is a solution to the given equation?

- A) 4
- B) 2
- C) 0
- D) -2

8

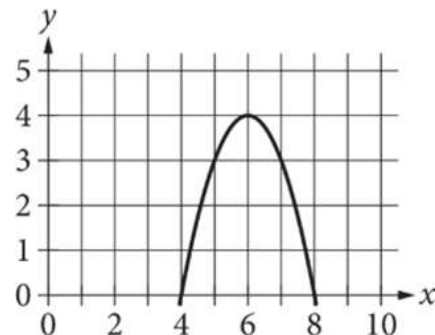

What is an equation of the graph shown?

- A) $y = -(x - 4)^2 + 8$
- B) $y = (x + 4)^2 - 8$
- C) $y = -(x - 6)^2 + 4$
- D) $y = (x + 6)^2 - 4$

9

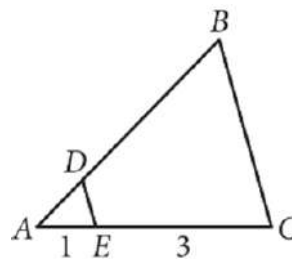

In the figure shown, triangle ABC is similar to triangle ADE such that B corresponds to D and C corresponds to E . The measure of angle ABC is 60° . What is the measure of angle ADE ?

- A) 15°
- B) 20°
- C) 45°
- D) 60°



10

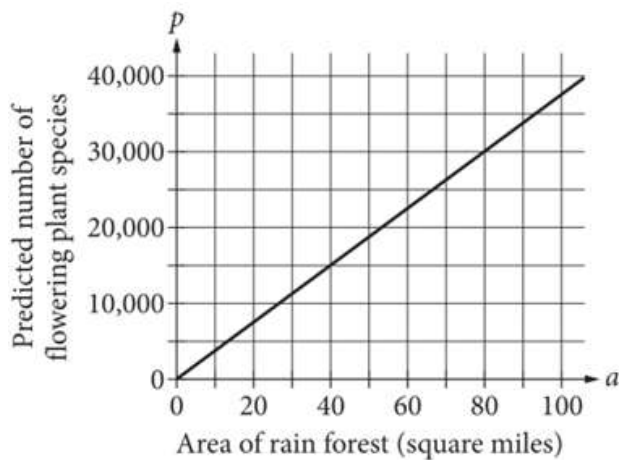

The graph models the relationship between the area of a rain forest a , in square miles, and the predicted number of flowering plant species, p , found in that area. What equation represents this relationship?

- A) $p = 200a$
- B) $p = 375a$
- C) $p = 500a$
- D) $p = 750a$

11

$$p = \frac{2}{n} + 3$$

The given equation relates the numbers p and n , where n is not equal to 0 and $p > 3$. Which equation correctly expresses n in terms of p ?

- A) $n = \frac{p}{2} - 3$
- B) $n = \frac{p}{2} + 3$
- C) $n = \frac{2}{p-3}$
- D) $n = -\frac{2}{p+3}$

12

$$y = 3x + 5$$

$$y = px + 8$$

In the given system of equations, p is a constant. The system has no solution. What is the value of p ?

- A) -3
- B) $-\frac{1}{3}$
- C) $\frac{1}{3}$
- D) 3



13

$$\sqrt{x}(\sqrt{x} + \sqrt{y})$$

Which of the following expressions is equal to the given expression, where $x \geq 0$ and $y \geq 0$?

- A) $x + \sqrt{xy}$
- B) $x + \sqrt{x+y}$
- C) $\sqrt{x^2 + xy}$
- D) $\sqrt{x^2 + x + y}$

14

Joe was asked to memorize a list of 200 vocabulary words, and he was assessed on his memorization of the words over 3 days. On day 1, he remembered all 200 words. On each of the next two days, Joe remembered 10% fewer words than he did the preceding day. How many words did Joe remember on day 3 ?

- A) 160
- B) 162
- C) 172
- D) 180

15

$$x^2 + y^2 - 16x - 4y + 32 = 0$$

In the xy -plane, the graph of the given equation is a circle. What is the length of the radius of this circle?

- A) 2
- B) 6
- C) 8
- D) 36



DIRECTIONS

For questions 16-20, solve the problem and enter your answer in the grid, as described below, on the answer sheet.

- Although not required, it is suggested that you write your answer in the boxes at the top of the columns to help you fill in the circles accurately. You will receive credit only if the circles are filled in correctly.
- Mark no more than one circle in any column.
- No question has a negative answer.
- Some problems may have more than one correct answer. In such cases, grid only one answer.
- Mixed numbers** such as $3\frac{1}{2}$ must be gridded as 3.5 or $7/2$. (If $\begin{array}{|c|c|c|c|} \hline 3 & 1 & / & 2 \\ \hline \bullet & \bullet & \bullet & \bullet \\ \hline \end{array}$ is entered into the grid, it will be interpreted as $\frac{31}{2}$, not $3\frac{1}{2}$.)
- Decimal answers:** If you obtain a decimal answer with more digits than the grid can accommodate, it may be either rounded or truncated, but it must fill the entire grid.

Answer: $\frac{7}{12}$

Write answer → in boxes.

7	/	1	2
•	•	•	•
0	0	0	0
1	1	•	1
2	2	2	•
3	3	3	3
4	4	4	4
5	5	5	5
6	6	6	6
•	7	7	7
8	8	8	8
9	9	9	9

← Fraction line

Grid in result.

Answer: 2.5

	2	.	5
•	•	•	•
0	0	0	0
1	1	1	1
2	•	2	2
3	3	3	3
4	4	4	4
5	5	5	•
6	6	6	6
7	7	7	7
8	8	8	8
9	9	9	9

← Decimal point

Acceptable ways to grid $\frac{2}{3}$ are:

	2	/	3
•	•	•	•
0	0	0	0
1	1	1	1
2	•	2	2
3	3	3	•
4	4	4	4
5	5	5	5
6	6	6	6
7	7	7	7
8	8	8	8
9	9	9	9

.	6	6	6
•	•	•	•
0	0	0	0
1	1	1	1
2	2	2	2
3	3	3	3
4	4	4	4
5	5	5	5
6	•	•	•
7	7	7	7
8	8	8	8
9	9	9	9

.	6	6	7
•	•	•	•
0	0	0	0
1	1	1	1
2	2	2	2
3	3	3	3
4	4	4	4
5	5	5	5
6	•	•	•
7	7	7	•
8	8	8	8
9	9	9	9

Answer: 201 – either position is correct

	2	0	1
•	•	•	•
0	0	•	0
1	1	1	•
2	•	2	2
3	3	3	3

2	0	1	
•	•	•	•
0	•	0	0
1	1	•	1
•	2	2	2
3	3	3	3

NOTE: You may start your answers in any column, space permitting. Columns you don't need to use should be left blank.



16

$$|2x| = 64$$

What positive value of x satisfies the given equation?

17

The equation of line k is $y = 7x + 2$. What is the slope of a line that is parallel to line k in the xy -plane?

18

If $\frac{2}{3}p + 4 = 10$, what is the value of $3p$?



19

$$(x^3 - 6x + 5)(3x^2 + x)$$

If the given expression is rewritten in the form $ax^5 + bx^4 + cx^3 + dx^2 + ex$, where a , b , c , d , and e are constants, what is the value of d ?

20

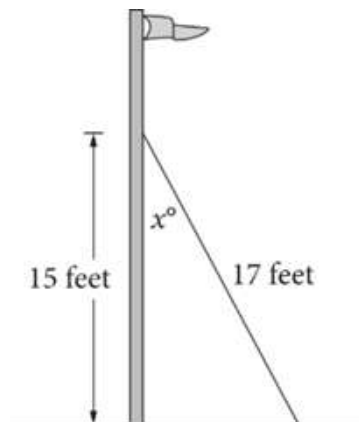

The figure shows the mast of a boat that is installed perpendicular to the deck of the boat. The mast is secured by a rope that is anchored to the deck. The rope measures 17 feet long and makes an angle of x° with the mast. The point where the rope is attached to the mast is 15 feet above the deck. What is the value of $\tan(x^\circ)$?

STOP

If you finish before time is called, you may check your work on this section only.

Do not turn to any other section.

No Test Material On This Page



Math Test – Calculator

55 MINUTES, 38 QUESTIONS

Turn to Section 4 of your answer sheet to answer the questions in this section.

DIRECTIONS

For questions 1-30, solve each problem, choose the best answer from the choices provided, and fill in the corresponding circle on your answer sheet. For questions 31-38, solve the problem and enter your answer in the grid on the answer sheet. Please refer to the directions before question 31 on how to enter your answers in the grid. You may use any available space in your test booklet for scratch work.

NOTES

- The use of a calculator is permitted.
- All variables and expressions used represent real numbers unless otherwise indicated.
- Figures provided in this test are drawn to scale unless otherwise indicated.
- All figures lie in a plane unless otherwise indicated.
- Unless otherwise indicated, the domain of a given function f is the set of all real numbers x for which $f(x)$ is a real number.

REFERENCE

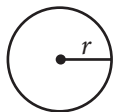

$$A = \pi r^2$$

$$C = 2\pi r$$

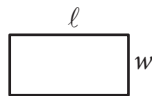

$$A = \ell w$$

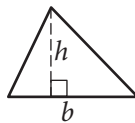

$$A = \frac{1}{2}bh$$

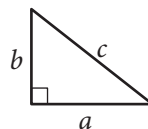

$$c^2 = a^2 + b^2$$

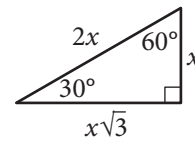

Special Right Triangles

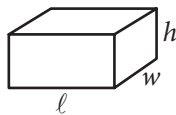
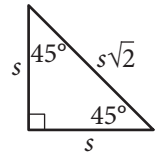

$$V = \ell wh$$

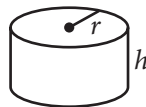

$$V = \pi r^2 h$$

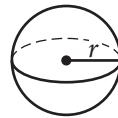

$$V = \frac{4}{3}\pi r^3$$



$$V = \frac{1}{3}\pi r^2 h$$

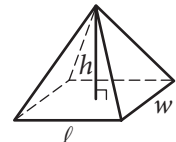

$$V = \frac{1}{3}\ell wh$$

The number of degrees of arc in a circle is 360.

The number of radians of arc in a circle is 2π .

The sum of the measures in degrees of the angles of a triangle is 180.



1

The function f is defined by $f(x) = 17x + 13$. What is the value of $f(8)$?

- A) 38
- B) 121
- C) 136
- D) 149

2

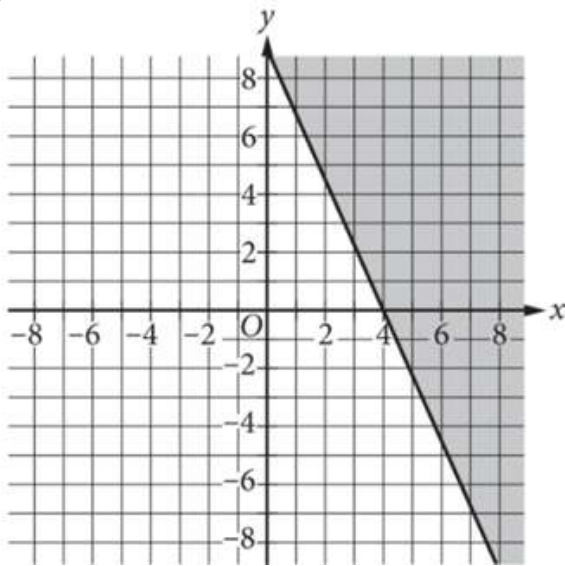

The shaded region shown represents all solutions to an inequality. Which ordered pair (x,y) is a solution to this inequality?

- A) (5,0)
- B) (0,5)
- C) (-5,0)
- D) (0,-5)

3

Leonardo da Vinci's rectangular painting *Mona Lisa* measures 21 inches wide and 30 inches long. An artist is creating a larger-scale replica of *Mona Lisa*, where the equation $A = (21x)(30x)$ gives the area of the replica, in square inches. Which of the following is the best interpretation of x in this context?

- A) The width of the replica is x inches greater than the width of the original *Mona Lisa*.
- B) The length of the replica is x inches greater than the length of the original *Mona Lisa*.
- C) The measure of each side of the replica is x times as great as the measure of the corresponding side of the original *Mona Lisa*.
- D) The area of the replica is x times as great as the area of the original *Mona Lisa*.

4

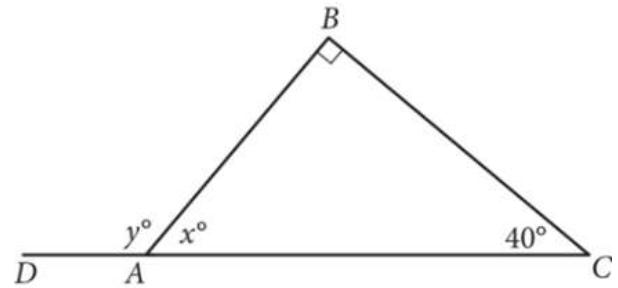

In triangle ABC , \overline{CA} is extended to point D . What is the value of y ?

- A) 50
- B) 115
- C) 130
- D) 140



Questions 5 and 6 refer to the following information.

Dakota and Alex work as babysitters. For each babysitting job, Dakota charges \$10 per hour plus a flat fee of \$5 for travel expenses. Alex charges \$8 per hour plus an additional fee of \$4 per child.

5

Dakota and Alex have different babysitting jobs where each will be babysitting 4 children for the same amount of time. If they charge the same total amount, in dollars, for their respective jobs, how many hours will each spend babysitting?

- A) 2.0
- B) 3.0
- C) 5.5
- D) 10.5

6

Which graph shows the relationship between the time, in hours, that Dakota spends babysitting and the amount, in dollars, Dakota charges for each babysitting job?

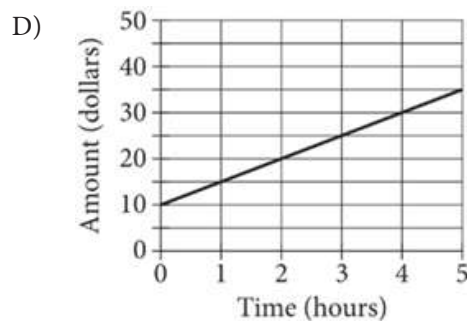
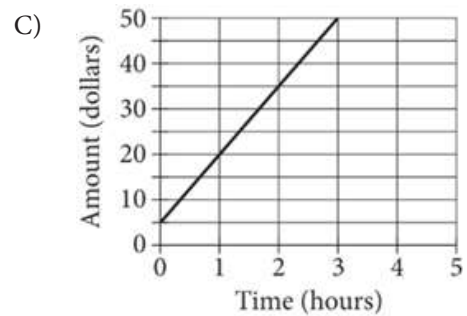
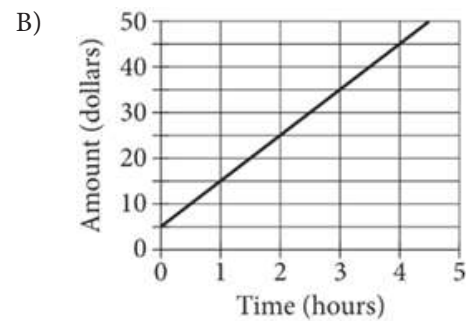
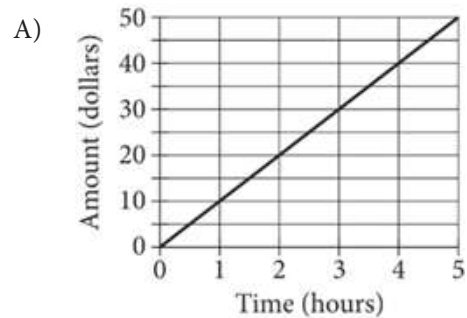



7

Line l has a slope of -3 and an x -intercept of $(\frac{9}{2}, 0)$. What is the y -intercept of line l ?

- A) $(\frac{9}{2}, 0)$
- B) $(0, \frac{9}{2})$
- C) $(\frac{27}{2}, 0)$
- D) $(0, \frac{27}{2})$

8

What is the range of the land areas, in thousands of acres, of the four parks in the table?

- A) 91.8
- B) 72.2
- C) 68.5
- D) 36.1

9

Questions 8 and 9 refer to the following information.

The table shows the approximate land areas, in thousands of acres, of four national parks in West Virginia.

National park	Area (in thousands of acres)
Bluestone National Scenic River	4.3
Gauley River National Recreation Area	11.6
Harpers Ferry National Historical Park	3.7
New River Gorge National River	72.2

A new data set with three values is formed by removing the data for New River Gorge National River. How does the mean area for the new data set compare to the mean area for the original data set?

- A) The mean area for the new data set is larger.
- B) The mean area for the new data set is smaller.
- C) The mean area for the new data set is the same.
- D) There is not enough information to compare the mean areas.



10

The mass y , in grams, of juvenile cobia fish x days after hatching can be modeled by the equation $y = -324 + 5.6x$, where $60 \leq x \leq 100$. Which graph represents this relationship?

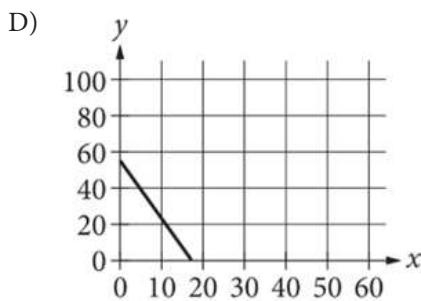
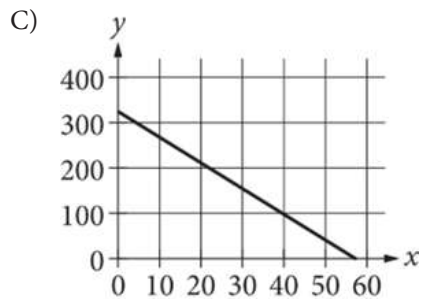
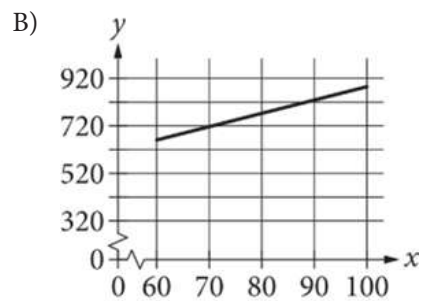
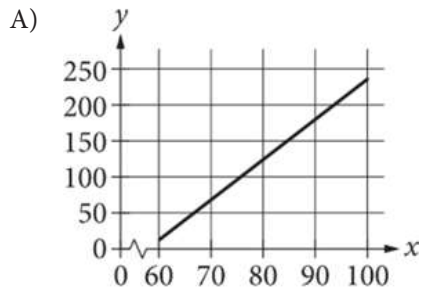

11

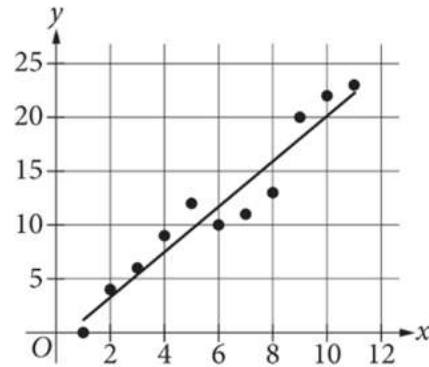

The scatterplot shows the relationship between two variables, x and y . A line of best fit is also shown. For how many of the data points does the line of best fit predict a greater y -value than the actual y -value?

- A) 11
- B) 7
- C) 4
- D) 1

12

Line k is defined by $y = 2x + 14$. Line j is perpendicular to line k in the xy -plane. What is the slope of line j ?

- A) $-\frac{1}{2}$
- B) $\frac{1}{14}$
- C) $\frac{1}{2}$
- D) 2



Questions 13 and 14 refer to the following information.

In 2015, a certain country had an adult population of 250 million people, of which 160 million were internet users and 90 million were not internet users. Of the adult population that used the internet, 52.8 million people had accessed two or more social media websites.

13

The adult population of this country in 2015 was 77% of the total population. Which of the following was the approximate total population of this country in 2015?

- A) 140 million
- B) 190 million
- C) 320 million
- D) 440 million

14

In 2015, what fraction of the adult internet users in this country had accessed two or more social media websites?

- A) $\frac{21}{100}$
- B) $\frac{33}{100}$
- C) $\frac{53}{100}$
- D) $\frac{59}{100}$

15

If $10(x + 9) = 9(x + 9) + 25$, what is the value of $x + 9$?

- A) -9
- B) 16
- C) 25
- D) 34

16

A biologist selected a sample of adult female Karner blue butterflies at random from a local population. The mean forewing length of the butterflies in the sample is 1.5 centimeters. The margin of error associated with this estimate for the population mean is 1 centimeter. If the biologist wants an estimate that has a smaller margin of error associated with it and can be generalized to the entire local population, which of the following changes should be made when the study is repeated?

- A) Using a different tool to measure the butterflies
- B) Measuring the butterflies at two different times of the day and comparing the results
- C) Selecting and measuring only the butterflies that look the smallest
- D) Selecting and measuring a larger random sample of the butterflies



17

The ratio of the diameter of a circle to its circumference is 1 to π . If the diameter of the circle is multiplied by 3, how will the circumference of the circle change?

- A) It will be multiplied by $\frac{1}{3}$.
- B) It will be multiplied by $\frac{\pi}{3}$.
- C) It will be multiplied by 3.
- D) It will be multiplied by 3π .

18

In the figure shown, all angles formed by adjacent sides are right angles.

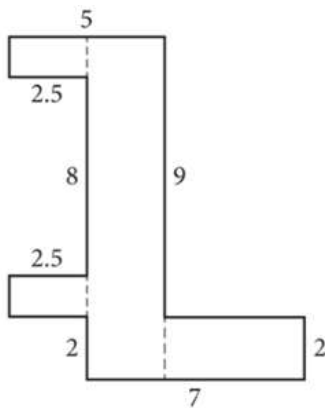

Note: Figure not drawn to scale.

What is the perimeter of the figure?

- A) 25
- B) 39
- C) 42
- D) 46

19

The tables show the frequencies of data values for two data sets.

Data Set P		Data Set Q	
Value	Frequency	Value	Frequency
0	1	4	1
1	1	5	1
2	2	6	2
3	3	7	3
4	6	8	6
5	5	9	5
6	4	10	4
7	3	11	3
8	3	12	3
9	2	13	2

Which statement best compares the mean a and standard deviation b of data set P with the mean c and standard deviation d of data set Q?

- A) $a < c; b < d$
- B) $a < c; b = d$
- C) $a > c; b = d$
- D) $a > c; b > d$



20

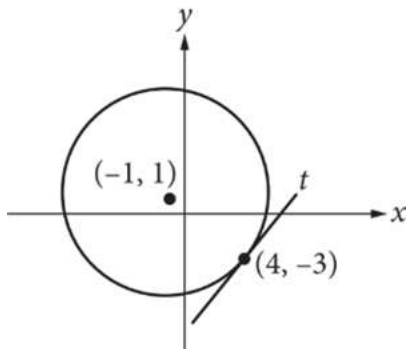

The circle shown has center $(-1, 1)$. Line t is tangent to this circle at point $(4, -3)$. Which of the following points also lies on line t ?

- A) $(0, \frac{5}{4})$
- B) $(3, 6)$
- C) $(8, 2)$
- D) $(9, 1)$

21

$$y = 3x + 6$$

$$y = -3x + 9$$

The solution to the given system of equations is (x, y) . What is the value of y ?

- A) 15
- B) 7.5
- C) 1.5
- D) 0.5

22

A researcher estimates that there is a population of 618 gray wolves in the Upper Peninsula of Michigan, which covers an area of approximately 16,452 square miles. Which of the following is closest to the estimated population density, in gray wolves per square mile, in this area?

- A) 0.04
- B) 3.76
- C) 26.62
- D) 53.24



23

In the xy -plane, exactly how many x -intercepts does the graph of $f(x) = x(x - 4)^2(x - 5)^3$ have?

- A) 2
- B) 3
- C) 5
- D) 6

24

The effectiveness of a mineral supplement in the soil on the growth of a particular species of plant is being studied. A botanist planted 1,000 seeds in a greenhouse so that the growing conditions for all seeds would be as identical as possible. The seeds were obtained from two 500-seed packages. The seeds from one package were planted in soil that had the supplement added, and the seeds from the second package were planted in soil that did not have the supplement added. How should the experiment be changed to allow the researcher to conclude whether the supplement has an effect on plant growth?

- A) One of the packages of seeds should be planted outdoors rather than in a greenhouse.
- B) Half of the seeds from each package should be randomly assigned to each soil type.
- C) All 1,000 seeds should receive the supplement.
- D) No changes to the experiment are needed.

25

Researchers estimated that 0.07%, by mass, of a 12-gram sample of an orchid plant consists of the fatty acid eicosadienoic acid. Based on this estimate, what is the mass of eicosadienoic acid, in grams, in this orchid sample?

- A) 0.0084
- B) 0.084
- C) 0.84
- D) 8.4



26

The population, in millions, of Suzhou, China, can be modeled by the function $p(t) = 1.1(1.066)^t$, where t represents the number of years after 1990, and $0 \leq t \leq 25$. Which of the following equations best models the population, in millions, of Suzhou, where n represents the number of years after 1995, and $0 \leq n \leq 25$?

- A) $r(n) = 1.1(1.066)^{5n}$
- B) $r(n) = 1.1(1.066)^{n-5}$
- C) $r(n) = 1.1(1.066)^5(1.066)^n$
- D) $r(n) = (1.1)^5(1.066)^5(1.066)^n$

27

$$x^2 + 6x + c = 0$$

In the given equation, c is a constant. The equation has exactly two distinct real solutions. Which statement about the value of c must be true?

- A) $c = 6$
- B) $c > 9$
- C) $c = 9$
- D) $c < 9$

28

A procedure allows a researcher to determine the concentration of glucose y , in micrograms per milliliter ($\mu\text{g/mL}$), in a soil sample by measuring the absorbance, x , at a specific wavelength of light. The scatterplot shows this relationship for 5 soil samples.

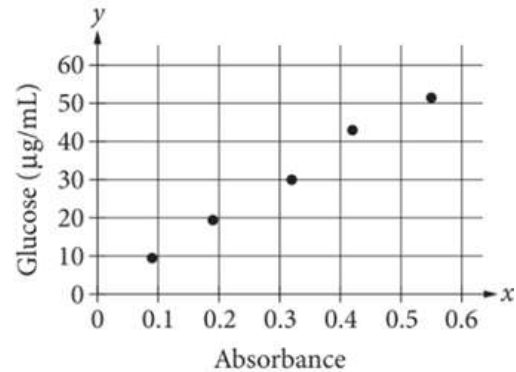

Which equation is the most appropriate linear model for the data?

- A) $y = 1.5 + 90x$
- B) $y = 1.5 + 10x$
- C) $y = 10 + 1.5x$
- D) $y = 90 + 1.5x$



29

A piece of paper is cut two times, resulting in three smaller pieces of paper of the same shape and size. Then, the three smaller pieces are stacked and cut two times to form nine even smaller pieces, each with the same shape and size. This process continues until the pieces of paper are too small to cut. Which of the following functions gives the number of pieces of paper, $F(c)$, that result after c cuts, where c is an even number?

- A) $F(c) = 3^{\frac{c}{2}}$
- B) $F(c) = 3^{\frac{c}{2} + 1}$
- C) $F(c) = 3^{2c}$
- D) $F(c) = 3^{2c + 1}$

30

There are 640 acres in 1 square mile. The area of a forest is increasing at a rate of 1 acre per decade. Which of the following is closest to the rate at which the area of the forest is increasing, in square kilometers per decade? (Use 1 kilometer = 0.62 mile.)

- A) 0.0006
- B) 0.0010
- C) 0.0025
- D) 0.0041

**DIRECTIONS**

For questions 31-38, solve the problem and enter your answer in the grid, as described below, on the answer sheet.

- Although not required, it is suggested that you write your answer in the boxes at the top of the columns to help you fill in the circles accurately. You will receive credit only if the circles are filled in correctly.
- Mark no more than one circle in any column.
- No question has a negative answer.
- Some problems may have more than one correct answer. In such cases, grid only one answer.
- Mixed numbers** such as $3\frac{1}{2}$ must be gridded as 3.5 or $7/2$. (If $\begin{array}{|c|c|c|c|} \hline 3 & 1 & / & 2 \\ \hline \bullet & \circ & \circ & \circ \\ \hline \end{array}$ is entered into the grid, it will be interpreted as $\frac{31}{2}$, not $3\frac{1}{2}$.)
- Decimal answers:** If you obtain a decimal answer with more digits than the grid can accommodate, it may be either rounded or truncated, but it must fill the entire grid.

Write answer in boxes. →

Answer: $\frac{7}{12}$

7	/	1	2
•	•	•	•
0	0	0	0
1	1	•	1
2	2	2	•
3	3	3	3
4	4	4	4
5	5	5	5
6	6	6	6
•	7	7	7
8	8	8	8
9	9	9	9

← Fraction line

Grid in result. →

Answer: 2.5

	2	.	5
•	•	•	•
0	0	0	0
1	1	1	1
2	•	2	2
3	3	3	3
4	4	4	4
5	5	5	•
6	6	6	6
7	7	7	7
8	8	8	8
9	9	9	9

← Decimal point

Acceptable ways to grid $\frac{2}{3}$ are:

	2	/	3
•	•	•	•
0	0	0	0
1	1	1	1
2	•	2	2
3	3	3	•
4	4	4	4
5	5	5	5
6	6	6	6
7	7	7	7
8	8	8	8
9	9	9	9

.	6	6	6
•	•	•	•
0	0	0	0
1	1	1	1
2	2	2	2
3	3	3	3
4	4	4	4
5	5	5	5
6	•	•	•
7	7	7	7
8	8	8	8
9	9	9	9

.	6	6	7
•	•	•	•
0	0	0	0
1	1	1	1
2	2	2	2
3	3	3	3
4	4	4	4
5	5	5	5
6	•	•	•
7	7	7	•
8	8	8	8
9	9	9	9

Answer: 201 – either position is correct

	2	0	1
•	•	•	•
0	0	•	0
1	1	1	•
2	•	2	2
3	3	3	3

2	0	1	
•	•	•	•
0	•	0	0
1	1	•	1
•	2	2	2
3	3	3	3

NOTE: You may start your answers in any column, space permitting. Columns you don't need to use should be left blank.



31

An observer counted the number of paddleboats on a lake each hour beginning at 8 a.m. The scatterplot shows these data.

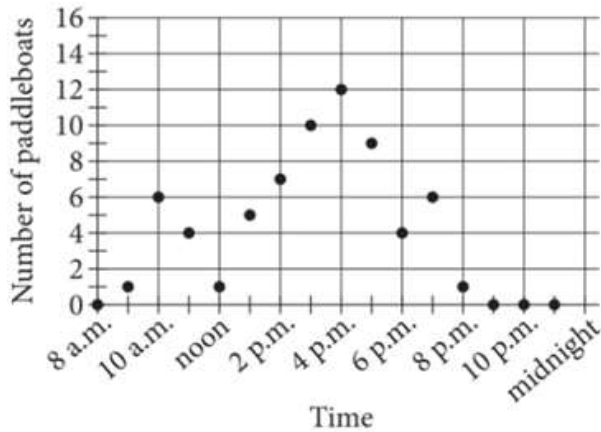

How many paddleboats were counted on the lake at 2 p.m.?

32

A company spent a total of \$9000 on digital and print ads. The ratio of the money spent on digital ads to the money spent on print ads was 1 to 3. How much money, in dollars, did the company spend on digital ads? (Disregard the \$ sign when entering your answer. For example, if your answer is \$4.97, enter 4.97)



33

$$x^2 + 2x - 1 = 0$$

A solution to the given equation is $\sqrt{k} - 1$. What is the value of k ?

34

$$C(x) = \frac{5}{9}(x - 32)$$

The function C gives the temperature, in degrees Celsius, that corresponds to a temperature of x degrees Fahrenheit. If a temperature increased by 19.8 degrees Fahrenheit, how much did the temperature increase in degrees Celsius? (Disregard the degree symbol when entering your answer.)



35

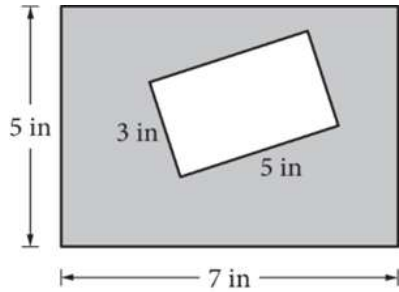

Note: Figure not drawn to scale.

The figure shows two rectangles. If a point within the figure is selected at random, what is the probability that the point is within the shaded region? (Express your answer as a decimal or fraction, not as a percent.)

36

$$-9x + 24qx = 36$$

In the given equation, q is a constant. The equation has no solution. What is the value of q ?



37

The value of r is $\frac{20}{21}$ times the value of t , where $t > 0$. The value of t is what percent greater than the value of r ? (Disregard the % sign when entering your answer. For example, if your answer is 39%, enter 39)

38

Two numbers, a and b , are each greater than zero, and 4 times the square root of a is equal to 9 times the cube root of b . If $a = \frac{2}{3}$, for what value of x is a^x equal to b ?

STOP

**If you finish before time is called, you may check your work on this section only.
Do not turn to any other section.**